



TMG-74

TMG SERIES

Top Mounted Medium Temp Glass Door Merchandisers

MODELS

- TMG-27
- TMG-48
- TMG-52
- TMG-74
- TMG-80



These ENERGY STAR[®] qualified models feature highly efficient compressors, generously-sized condensers and evaporators and EC evaporator motors. They may also qualify for energy rebate programs.

FEATURES

NEW STANDARD TEXTURED FINISH

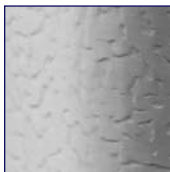

Standard white

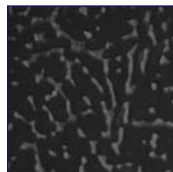

Black also available

CONSTRUCTION

- 24 gauge painted textured steel interior and exterior
- Cord and plug standard on all self-contained models
- Replaceable magnetic vinyl door gaskets
- 6"-7" adjustable metal legs
- Five white epoxy-coated, heavy-duty welded wire shelves with price tag molding per door (four cantilever and one bottom)
- Cantilever shelves are two-position and adjustable in 1" increments

- Equipped with high output T8 lamps and electronic ballasts
- Independent on/off light switch
- 2" foamed-in-place "zero ODP" urethane insulation

DOORS

- Door size:
 - TMG-27 29¹/₄" x 61¹/₄"
 - TMG-48/74 24³/₈" x 61¹/₄"
 - TMG-52/80 26³/₈" x 61¹/₄"
- Extra large, auto-close, double pane, safety glass doors
- Black door rails and handles
- Adjustable torsion bar hinges
- 90° hold-open feature
- Door hinges easily adjustable for closing tension and leveling

REFRIGERATION

- Refrigerant: R-134a
- Self-contained, factory tested, top mounted refrigeration system
- Top mounted low profile interior fan housing
- Minimum 4" clearance required between cabinet back and wall

- Temperature range: 34° to 41°F (1° to 5°C)
- R-factor (insulation efficiency rating): 17.24

WARRANTY

- Standard limited three year extended compressor and two year limited parts and labor

OPTIONS

- Add suffix "R" for remote system (available on TMG-48 and TMG-74 only)
- Add suffix "QC" for quick couple system
- Custom exterior colors
- Baskets
- Additional shelves
- Casters



TMG SERIES

TOP MOUNTED MEDIUM TEMP GLASS DOOR MERCHANDISERS

TECHNICAL SPECIFICATIONS

MODEL	DIMENSIONS (in.)			DIMENSIONS (mm)			VOLTS	AMPS	UNIT H.P.	NO. OF DOORS	CAP. CU. FT.	SHIP CU. FT.	SHIP WT. LB/KG
	L	D	H*	L	D	H							
TMG-27	31	35 ³ / ₄	85	787	908	2159	115	6.5	1/5	1	27.5	79.0	490/223
TMG-48	52	35 ³ / ₄	85	1321	908	2159	115	7.5	1/3	2	49.0	117.0	685/311
TMG-52	56	35 ³ / ₄	85	1422	908	2159	115	7.5	1/3	2	53.0	128.0	700/318
TMG-74	78	35 ³ / ₄	85	1981	908	2159	115	11.3	1/2	3	75.5	168.7	930/423
TMG-80	84	35 ³ / ₄	85	2134	908	2159	115	11.3	1/2	3	81.6	185.0	960/436

*Height includes 6"-7" adjustable legs.

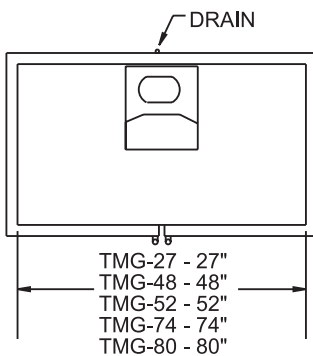

PLAN VIEW

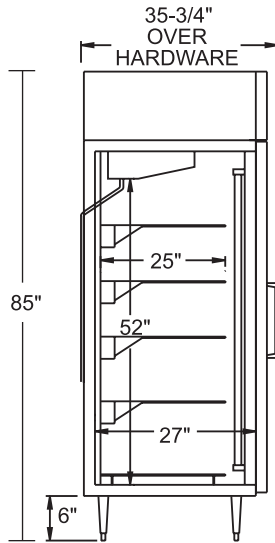

SIDE VIEW

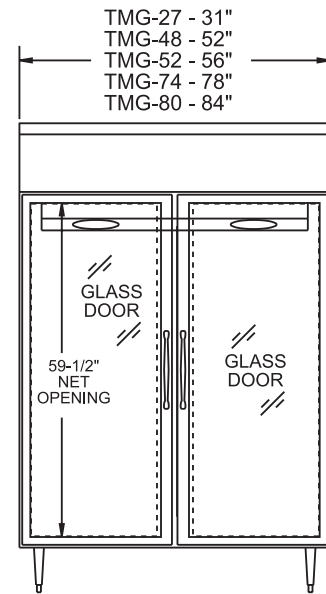

ELEVATION VIEW

LISTINGS



HOOKUP

Via plug in, 9 foot long flexible three wire 14/3 cord with molded plug.

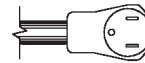

NEMA 5-15P (TMG-27, -48 and -52)

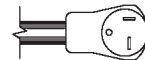

NEMA 5-20P (TMG-74 and -80)

BID SPECIFICATIONS

Item no. TMG-_____
Provide _____ () Top Mounted Medium Temperature Glass Door Merchandiser(s), Master-Bilt model no. TMG-_____.

Merchandiser will feature textured finish on interior and exterior. Other standard features include adjustable torsion bar hinges, top mounted low profile interior

fan housing, electric condensate evaporator, metal legs with 6"-7" adjustable range, T8 bulbs, independent on/off light switch and black door rails and handles. Five white epoxy-coated shelves (four cantilever and one bottom) with price tag molding per door will also be standard.

The refrigeration system is to be top mounted, self-contained and use R-134a

refrigerant. The temperature range will be 34° to 41°F (1° to 5°C).

Merchandiser to have standard limited three year extended compressor warranty and two year limited parts and labor warranty.

Merchandiser to be UL, C-UL and NSF listed as well as ENERGY STAR qualified.

NOTE: Cabinet designed for optimum performance in air-conditioned area at 75°F ambient and 55% relative humidity. All specifications subject to change without notice.



908 Highway 15 North • New Albany, MS 38652

PHONE: 800-647-1284 or 662-534-9061 • FAX: 800-232-3966 or 662-534-6049 • www.master-bilt.com

