

ITEM NO. \_\_\_\_\_  
 PROJECT \_\_\_\_\_  
 LOCATION \_\_\_\_\_  
 DATE \_\_\_\_\_ QTY. \_\_\_\_\_



## MNR/MNF SERIES Top Mounted Solid Door Reach-Ins

### REFRIGERATORS

- MNR241
- MNR522
- MNR803

### FREEZERS

- MNF241
- MNF522
- MNF803



## FEATURES

### STANDARD ELECTRONIC CONTROL

- Increases efficiency, reliability and convenience
- Allows user to easily monitor and adjust defrost functions from the panel interface on the front of the merchandiser
- Decreases service time and calls
- Eliminates cabinet thermostat, defrost timer and digital thermometer or other temperature indicator

### CONSTRUCTION

- Exterior front, sides and doors are stainless steel
- Exterior top, bottom and back are galvanized steel
- All exterior joints and seams fold in without lap joints
- Interior liner and door panel are stainless steel
- 2" foamed-in-place polyurethane insulated walls

- 4" diameter casters (4 on one- and two-door models, 6 on three-door models)
- Three heavy-duty epoxy-coated shelves per section
- Recessed interior incandescent light activated by switches for each door

### DOORS

- Available with lefthand or righthand door swing
- Heavy-duty pivot hinges
- Centered key locks
- Horizontal handles
- Self-adjusting magnetic gaskets
- Freezer models have complete perimeter, anti-condensate door opening heater wires

### REFRIGERATION

- Top mounted, self-contained refrigeration system
- Refrigerant: R-134a for refrigerators, R-404A for freezers
- Automatic defrost
- Automatic energy efficient hot gas condensate evaporator

- Refrigerant controlled by capillary tube in refrigerators, by thermostatic expansion valve in freezers
- Minimum 4" clearance required on top, rear and sides of cabinet
- Temperature range: 34° to 41°F (1° to 5°C) for refrigerators, -5°F to 5°F (-21°C to -15°C) for freezers

### WARRANTY

- Standard limited three year extended compressor and two year limited parts and labor

### OPTIONS

- Extra epoxy-coated shelves
- Extra stainless steel shelves
- Full glass doors (refrigerators only)
- Half glass doors (refrigerators only)
- Half solid doors
- Legs in lieu of casters
- Full door pan slides
- Half door pan slides
- 220/50/1 CE approved for export

**TECHNICAL SPECIFICATIONS**

MODEL	DIMENSIONS (in.)			DIMENSIONS (mm)			VOLTS	AMPS	UNIT H.P.	NO. OF DOORS	NO. OF SHELVES	STANDARD SHELF SIZE (in inches)	CAP. CU. FT.	SHIP CU. FT.	SHIP WT. LB/KG
	L	D	H*	L	D	H*									
<b>REFRIGERATORS</b>															
MNR241	27 <sup>1</sup> / <sub>2</sub>	35 <sup>1</sup> / <sub>8</sub>	81 <sup>1</sup> / <sub>2</sub>	699	892	2070	115	4.9	1/4	1	3	23L x 28D	24.0	55.2	365/166
MNR522	55	35 <sup>1</sup> / <sub>8</sub>	81 <sup>1</sup> / <sub>2</sub>	1397	892	2070	115	8.0	1/3	2	6	24 <sup>1</sup> / <sub>2</sub> L x 28D	51.9	105.3	545/248
MNR803	82 <sup>1</sup> / <sub>2</sub>	35 <sup>1</sup> / <sub>8</sub>	81 <sup>1</sup> / <sub>2</sub>	2096	892	2070	115	9.1	1/2	3	9	24 <sup>1</sup> / <sub>2</sub> L x 28D	79.9	153.4	750/341
<b>FREEZERS</b>															
MNF241	27 <sup>1</sup> / <sub>2</sub>	35 <sup>1</sup> / <sub>8</sub>	81 <sup>1</sup> / <sub>2</sub>	699	892	2070	115	9.7	1/2	1	3	23L x 28D	24.0	55.2	375/170
MNF522	55	35 <sup>1</sup> / <sub>8</sub>	81 <sup>1</sup> / <sub>2</sub>	1397	892	2070	115	13.7	3/4	2	6	24 <sup>1</sup> / <sub>2</sub> L x 28D	51.9	105.3	660/300
MNF803	82 <sup>1</sup> / <sub>2</sub>	35 <sup>1</sup> / <sub>8</sub>	81 <sup>1</sup> / <sub>2</sub>	2096	892	2070	115	13.8	1	3	9	24 <sup>1</sup> / <sub>2</sub> L x 28D	79.9	153.4	805/366

\*Height includes casters. With optional 6" legs overall height is 82<sup>3</sup>/<sub>4</sub>"

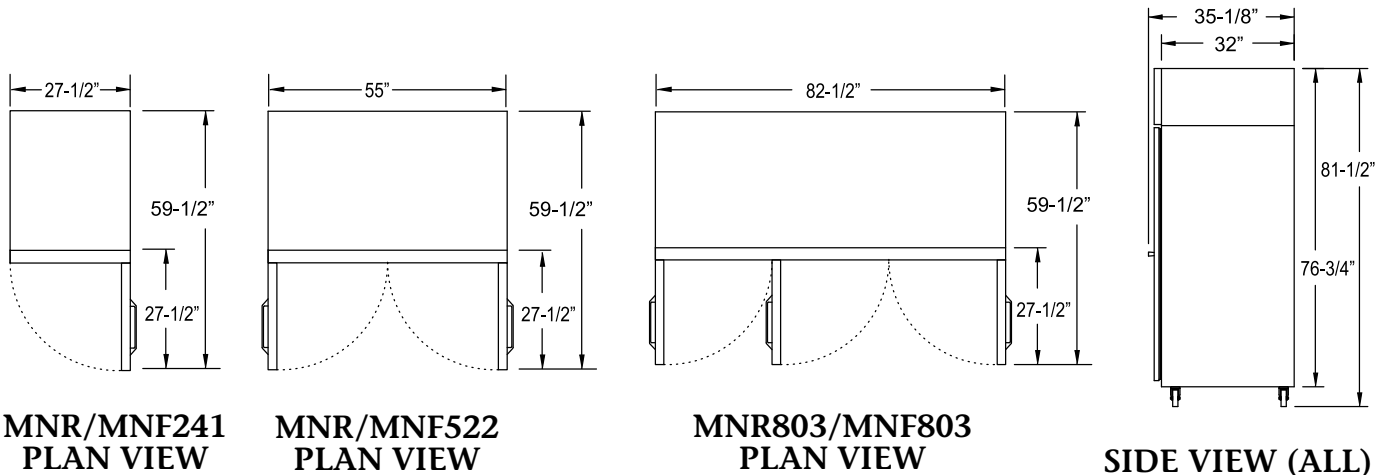

**LISTINGS**



**HOOKUP**

MNR241, MNR522, MNR803, MNF241:  
Via plug in, 10 foot long flexible three wire 14/3 cord with molded plug.  
MNF522, MNF803: Via plug in, 10 foot long flexible three wire 12/3 cord with molded plug.

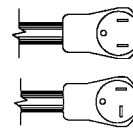

NEMA 5-15P (MNR241, MNR522, MNR803, MNF241)  
NEMA 5-20P (MNF522, MNF803)

**BID SPECIFICATIONS**

Item no. \_\_\_\_\_  
Provide \_\_\_\_\_ ( ) Top Mounted Solid Door Reach-in(s), Master-Bilt model no. \_\_\_\_\_.

Reach-in will be equipped with an electronically controlled monitoring system and will feature stainless steel exterior front, sides and doors. The exterior top,

bottom and back will be galvanized steel while the interior liner and door panel will be stainless steel.

The refrigeration system will be top mounted and self-contained. Freezers will use R-404A refrigerant, refrigerators will use R-134a. The temperature range will be 34° to 41°F (1° to 5°C) for refrigerators, -5°F

to 5°F (-21°C to -15°C) for freezers.

Reach-in to have standard limited three year extended compressor warranty and two year limited parts and labor warranty.

Reach-in to be UL and C-UL listed, UL EPH classified and California Energy Code certified.

**NOTE:** Cabinet designed for optimum performance in air-conditioned area at 75°F ambient and 55% relative humidity. All specifications subject to change without notice.